

5.Installation

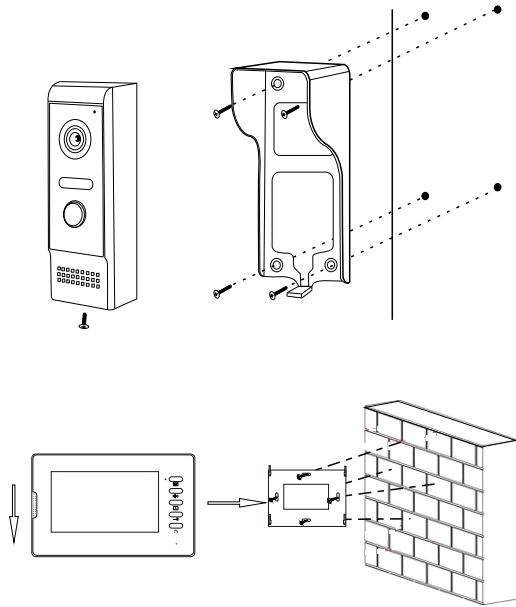

Indoor unit Standard installation height is 145cm~160cm (distance between screen centre and the floor)

Outdoor unit Standard installation height is 145cm~160cm (distance between camera and the floor)

VIDEO DOOR PHONE FOR VILLA

USER MANUAL

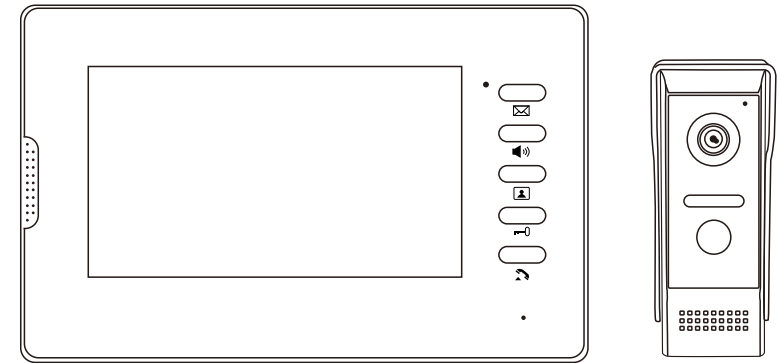

6.Parameters

Indoor unit		Outdoor unit	
Power Supply	Input:AC100-240V Output:DC12v-15v 1500mA	Power Supply	Receive power from monitor
Power	Standby: ≤1W Working: ≤10W	Power	Standby: ≤0W Working: ≤2W
Screen	TFT Liquid Crystal Display	Camera	30W
Wiring	4 OR 5 PIN Line RVV	Night Version	WLED, Super backlight compensation
Timing	Intercom:90 seconds Monitoring:90 seconds	Working Temperature	-30℃ - +60℃
Ringtone	25 chord		
Working Temperature	-20℃ - +60℃		

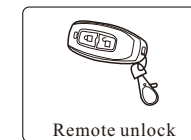
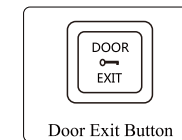
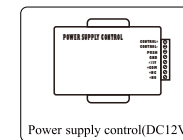
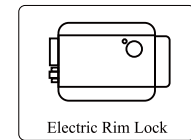
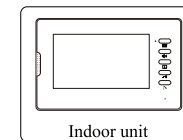

Please read all of these instruction before installation

1. Indoor unit

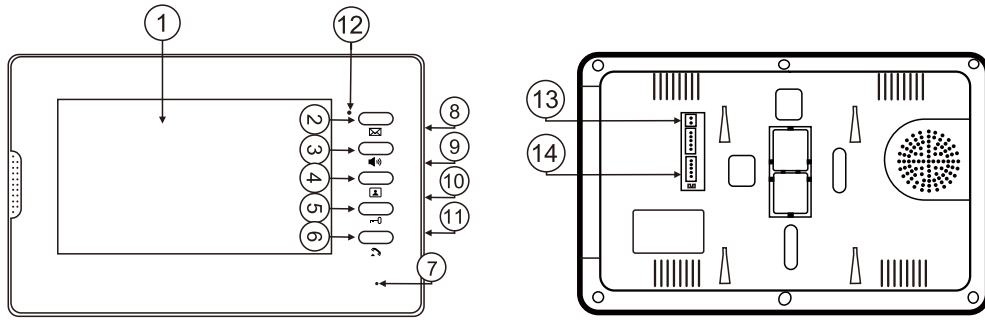

- ①. TFT-LCD display screen
- ②. Ring cancel
- ③. Ring tone & Ring volume adjustment
- ④. Monitor button
- ⑤. Unlock button
- ⑥. Intercom or call button
- ⑦. Microphone
- ⑧. Screen brightness adjustment
- ⑨. Screen color adjustment
- ⑩. Null
- ⑪. Intercom volume adjustment
- ⑫. Power LED
- ⑬. DC15V Adaptor sockets
- ⑭. Sockets for outdoor unit connection
(The same function for two sockets)

2. Outdoor unit

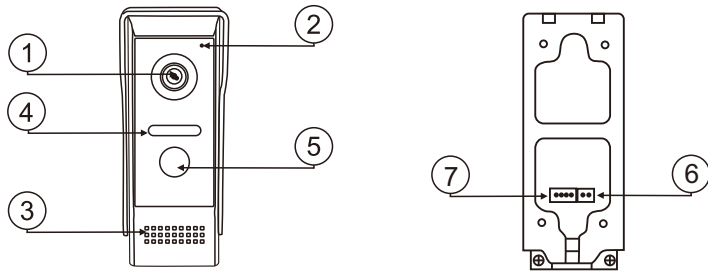

- ①. Camera
- ②. MIC
- ③. Speaker
- ④. LED
- ⑤. Call button
- ⑥. "L+L-" Sockets for lock
- ⑦. 7P Sockets for indoor unit

3. Operating Instructions

a. Settings

Three settings can be adjusted by the turbine (on the right side)

1. Brightness of screen
2. Color of screen
3. Volume of communication

b. Indoor station volume & music setting

1. Music settings

Press the "Monitor button" enter into working state, then press "Ring tone & Ring volume adjustment button", you will hear the ring, at the same time, you can adjust the ring tone, 36 ring tones can be chosen, after all, closed the monitor button, finished the music settings.

2. Ring volume settings

Press the "Monitor button" enter into working state, then press "Ring tone & Ring volume adjustment button", you will hear the ring, and then keep pressing this button hold 2 seconds, the ring volume will change to higher or lower. There are three levels to choose, you can choose the best.

3. Ring cancel settings

4 wire indoor monitor: Press the "Monitor button" enter into working state, then press "Ring cancel button" hold 5 seconds, the ring tone will be "OPEN" or "CLOSE".

5 wire indoor monitor: Press the "Monitor button" enter into working state, then press "Ring cancel button" less 1 second, the ring tone will be "OPEN" or "CLOSE".

This function won't affect the image from the screen.

Note: you can press the "Ring tone & Ring volume adjustment button" to test whether you had succeeded to setting this function.

4. Connection of the video doorphone

